

SRP-X500P Manager

User's Guide

Software Version 1.0

Before using the software, please read this User's Guide and the Operating Instructions of the SRP-X500P Digital Powered Mixer thoroughly and retain them for future reference.

SRP-X500P

Table of Contents

Overview.....	3
Features	3
Using the supplied CD-ROM.....	3
Operating conditions	3
Preparation.....	4
Installing the SRP-X500P Manager	4
Uninstalling	4
Names and Functions of Controls on Screen.....	5
Common operation section	5
BLOCK screen.....	6
PANEL VIEW screen	9
OVER VIEW screen	10
REMOTE FADER screen.....	15
PARALLEL/PROJECTOR CONTROL screen.....	16
SCENE MEMORY screen.....	18
About the Mixer's Internal Preset Memory.....	19
SYSTEM TYPE preset memory	19
PROJECTOR PROTOCOL preset memory	20
To Control the Projector Whose Protocol Is Not Preset to the Mixer	21
Appendix	25
Factory settings (SYSTEM TYPE 0).....	25

Overview

Features

The SRP-X500P Manager is a program which allows you to make parameter settings for the SRP-X500P Digital Powered Mixer.

Various effector settings

Detailed settings on equalizer, automatic gain control, compressor, etc. can be performed. The SRP-X500P Manager is provided with visual aids including graphs to allow easy operation.

Remote settings

Settings for the REMOTE PARALLEL connector on the rear of the SRP-X500P Digital Powered Mixer and settings for projector control can be performed.

Scene memory

You can store the settings as scene files to the internal memory of the SRP-X500P Digital Powered Mixer. You can change the settings at a time by recalling the scene.

Using the supplied CD-ROM

The CD-ROM contains the following files.

SRP-X500P Manager

This is a program for setting the SRP-X500P parameters from a PC.

SRP-X500P Manager User's Guide

This is a PDF file containing information on the functions and operations of the SRP-X500P Manager. Can be viewed on a PC.

SRP-X500P Operating Instructions

This is a PDF file containing information on the functions and operations of the SRP-X500P Digital Powered Mixer. Can be viewed on a PC.

To open these PDF files, Adobe Acrobat or Adobe Reader must be installed on your PC.

To get Adobe Reader, go to the website of Adobe Systems Incorporated (<http://www.adobe.com/>).

Operating conditions

The recommended operating environment for using the SRP-X500P Manager is as follows.

OS	Microsoft Windows Millennium Edition Microsoft Windows 2000 Professional Microsoft Windows XP Professional Microsoft Windows XP Home Edition
CPU	Celeron 400 MHz or higher
RAM	128 MB of RAM or greater
Available hard disk space	20 MB of available hard-disk space

Notes on use

- The PC must be preinstalled with one of the OS listed above. Operation of this software when the OS has been upgraded is not guaranteed.
- Operation this software is not guaranteed in every PC, even if the recommended environment is satisfied.

Preparation

Installing the SRP-X500P Manager

- 1 Insert the supplied CD-ROM into the CD-ROM drive of the personal computer.
- 2 Open the SRP-X500P Manager\English folder double-click the Setup icon.
“Welcome to the SRP-X500P Manager setup wizard.” screen appears.
- 3 Click “Next”.
“Select Installation Folder.” screen appears.

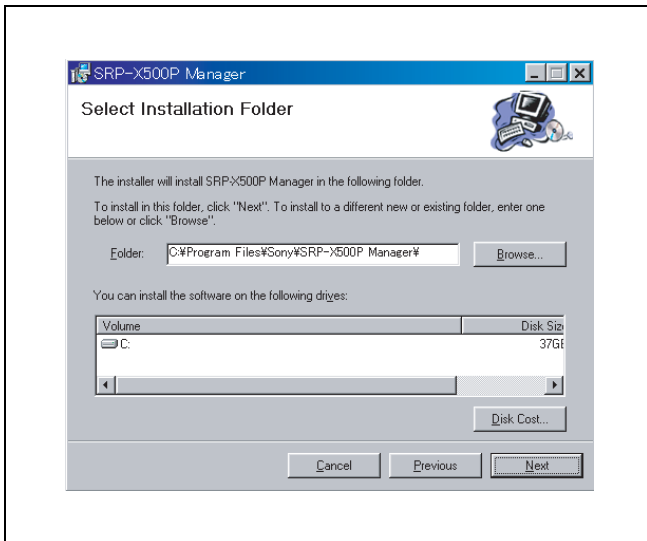

The SRP-X500P Manager folder is created in C:\Program Files. To change the installation destination, click “Browse...”.

- 4 After specifying the installation destination, click “Next”.
“Confirm Installation.” screen appears.
- 5 Click “Next”.
Installation starts.
- 6 After “Installation Complete.” screen appears, click “Close”.
“Confirm Installation.” screen appears.

Installation of the SRP-X500P Manager is now complete.

Uninstalling

- 1 Click the Start menu and select “Settings (S)”. Then click “Control Panel” to open it.
- 2 Double-click the “Add/Remove Programs” icon and select “SRP-X500P Manager” from the list of the “Install/Uninstall” tab.
- 3 Click “Add/Remove (R)...”.

This completes the uninstallation.

Note

When using Microsoft Windows 2000 Professional, Microsoft Windows XP Professional or Microsoft Windows XP Home Edition, be sure to log on as the user having administrator authority, then perform the installation or uninstallation.

Names and Functions of Controls on Screen

Common operation section

The controls shown below appear on all the screens.

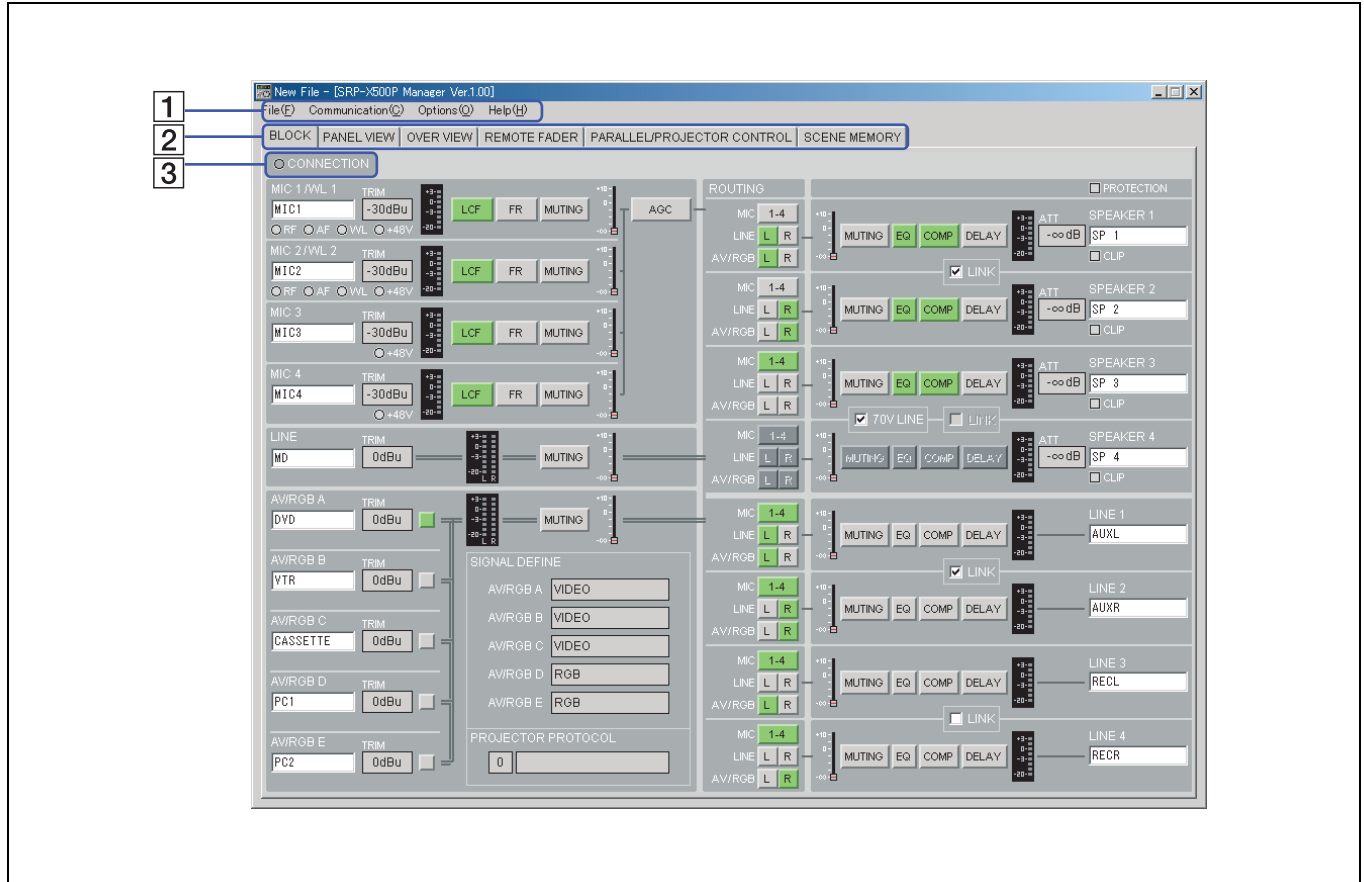

1 Menu bar

The titles of the menus are displayed.

You can perform operations that are common to the basic settings and each setup screen.

1 File menu

This software allows you to save the parameters of up to 8 scenes and the information in a single setup file (*.x5p).

New: Creates a new setup file. Cannot be selected when communication between the SRP-X500P Manager and the SRP-X500P Digital Powered Mixer (referred to as “mixer” hereafter) is active.

Open: Opens an existing setup file. When “Open” is selected while the communication between the SRP-X500P Manager and the mixer is active, all parameters within the current setup file is transmitted to the mixer.

Open scene: Opens the specified scene number from the 8 scenes in the existing setup file.

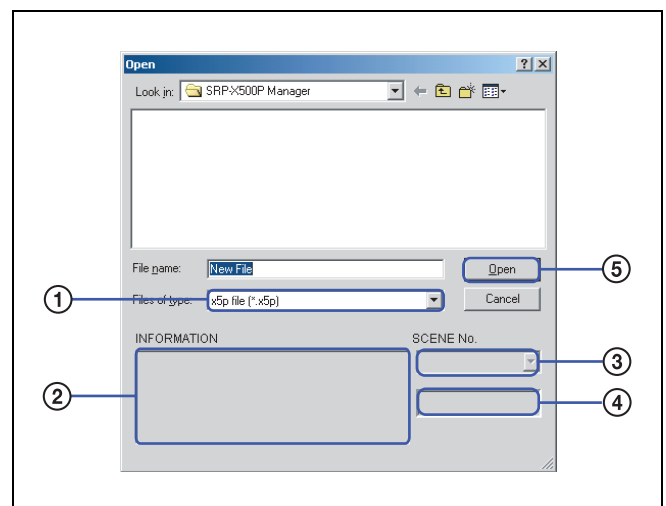

- 1 Select a setup file.
- 2 The information contained in the selected setup file is displayed.
- 3 Select the scene number.

- ④ The index of the selected scene number is displayed.
- ⑤ Click the Open button.

Save: Saves the new data by overwriting the existing data.

Save as: Saves the data under a different name.

Exit: Exits the SRP-X500P Manager.

② Communication menu

Activates/deactivates the communication between the SRP-X500P Manager and the mixer. Also specifies the port number for RS-232C communication.

Connect: Activates communication. Cannot be selected when the communication between the SRP-X500P Manager and the mixer is already activated.

Disconnect: Deactivates communication. Cannot be selected when the communication between the SRP-X500P Manager and the mixer is already deactivated.

Port select: Specifies the port number for RS-232C communication to be used for SRP-X500P Manager operation.

③ Options menu

Factory preset: Resets all parameters to the default settings.

Password setting: You can set a password.

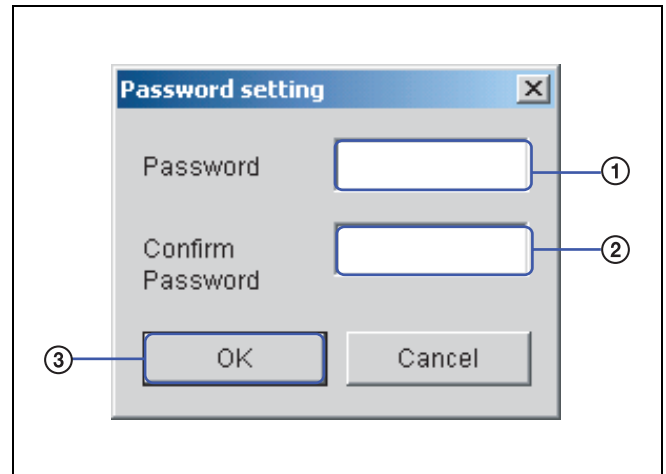

- ① Enter a password.
- ② For confirmation, enter the same password again.
- ③ Click "OK".

Note

If you enter the wrong password, you cannot start the SRP-X500P Manager. Be sure to take a note of the password. If you forget the password, uninstall the software and then reinstall it from the supplied CD-ROM.

④ Help menu

About: The version of the software appears.

② Screen selection tabs

Click to select the setup screen for each parameter.

③ CONNECTION indicator

Lights up green when the communication between the SRP-X500P Manager and the mixer is activated.

BLOCK screen

The BLOCK screen shows the internal block diagram of the mixer. You can click the button to turn each function on or off while monitoring overall settings on this screen.

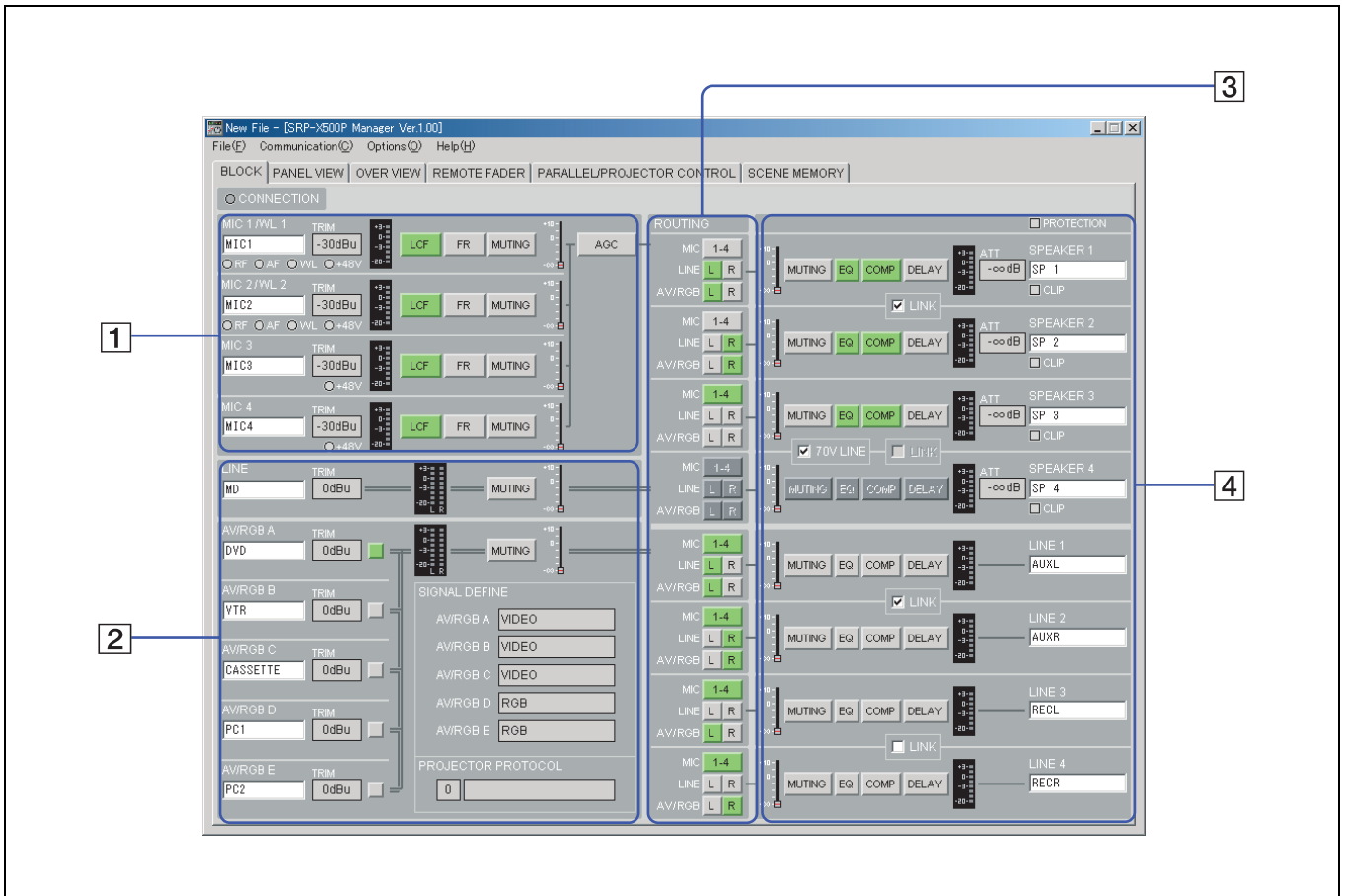

1 MIC INPUT setting section

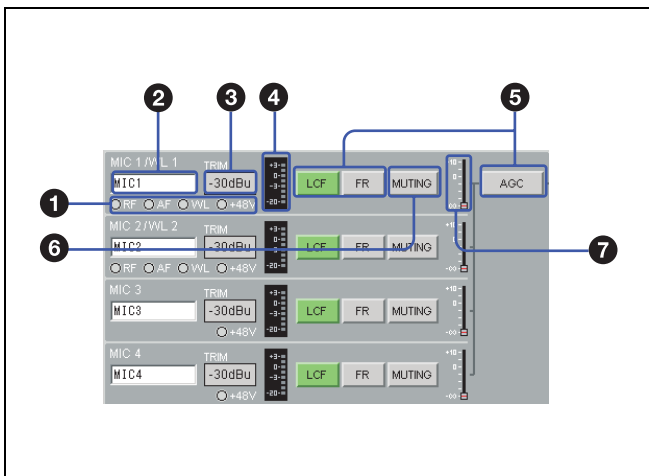

1 Indicators

These are the indicators of microphone input.

RF: Lights up green when the RF signal is input to the wireless tuner unit which is installed in the mixer.

AF: Lights up yellow when the audio signal is input to the wireless tuner unit which is installed in the mixer.

WL: Lights up green when the signal is input to the mixer from the wireless tuner unit installed to the mixer. As long as this indicator is lit, the mixer selects the signal input from the wireless tuner unit.

+48V: Lights up red when the +48 V ON/OFF switch on the mixer is set to ON.

2 Index name input box

You can enter an index name for each input channel. Up to eight alphanumeric characters can be entered.

3 TRIM indication

Displays the reference level of the input channel specified by the TRIM control on the mixer within the range of -60 dBu to -30 dBu.

4 Level meter

Displays the signal level of the input channel.

5 LCF, FR/EQ, and AGC buttons

Click to turn each function on or off. The button lights up green when it is set to on.

6 MUTING button

Left-click to turn muting function on or off. The button lights up red when it is set to on.

7 Fader level indication

Displays the fader level of the input signal. The displayed value is the summation of the level of the INPUT fader and remote fader specified by the software and the input level control setting on the mixer.

2 LINE, AV/RGB INPUT setting section

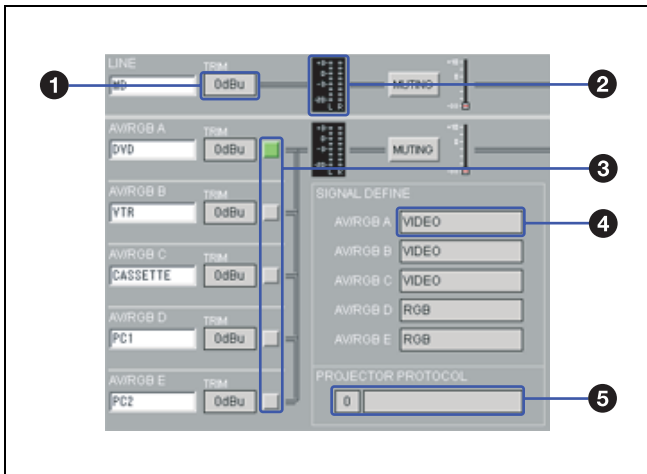

1 TRIM indication

Displays reference level specified by the TRIM control on the mixer.

2 Level meter

Displays the signal level of each input channel.

3 AV/RGB SELECTOR buttons

Click to select one of the AV/RGB channels (A to E). The button for the selected channel lights up green.

4 SIGNAL DEFINE indication

Displays the signal format specified in the PROJECTOR CONTROL setting section of the REMOTE PARALLEL/PROJECTOR CONTROL screen.

5 PROJECTOR PROTOCOL indication

Displays the projector protocol setting specified by the PROJECTOR PROTOCOL selector on the mixer and model name of the projector.

For details on the MUTING button, fader level indication, entering the index name for the input signal, see “1 MIC INPUT setting section” of the BLOCK screen (page 7).

3 ROUTING setting section

With this section, you can select an output path for each input signal by assigning each input channel to an output channel.

Left-click a channel button to turn the corresponding channel on or off. Right-click the button to specify the sending level of the input signal to the output channel. When the channel button is set to on and the sending level is set to 0 dB, it lights up green. The button lights up blue when it is set to on and the sending level is set to -3 dB to -20 dB.

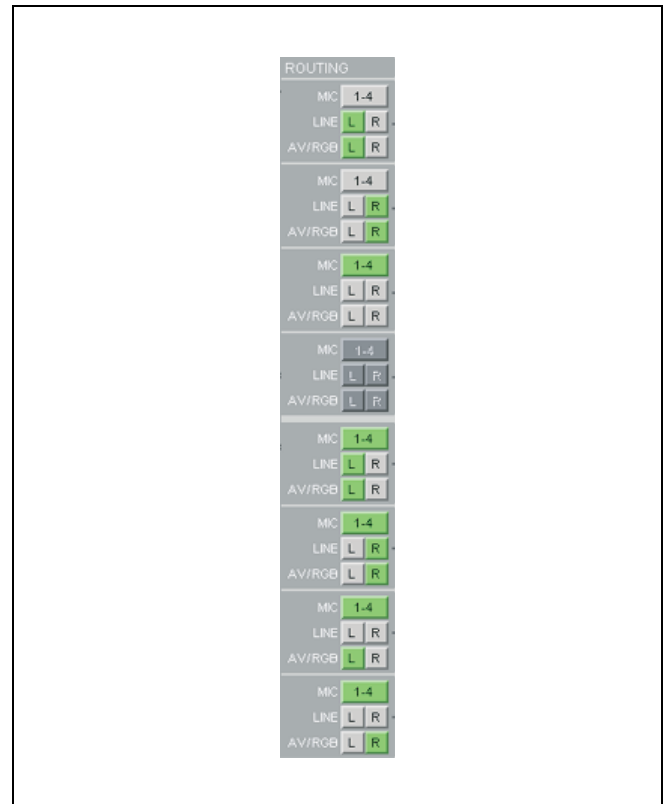

4 OUTPUT setting section

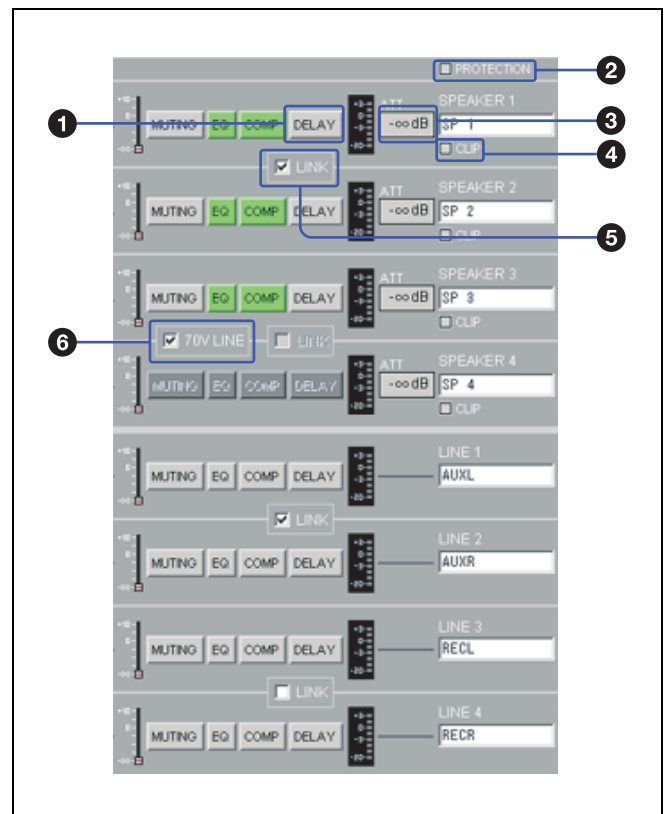

1 DELAY button

Click to turn the delay on or off. The button lights up green when the delay is set to on.

Note

The total amount of delay time to be set for the total output channel must not exceed 160 ms (54.7 m or 181.9 feet). For details, see “DELAY amount setup box” (page 13).

2 PROTECTION indicator

Lights up red when the PROTECTION indicator on the mixer lights up red.

3 ATT indication

Shows the attenuation level specified by the SPEAKER OUT controls on the mixer.

4 CLIP indicator

Lights up red when the CLIP indicator on the mixer lights up red.

5 LINK check box

Check the muting, compressor, delay, and output fader settings for the SPEAKER 1 and 2, SPEAKER 3 and 4, LINE 1 and 2, or LINE 3 and 4 to link with each other.

6 70V LINE check box

Check to set the SPEAKER 3 and 4 channels to 70V LINE.

PANEL VIEW screen

The PANEL VIEW screen shows the settings performed through the front panel of the mixer and the system type setting,

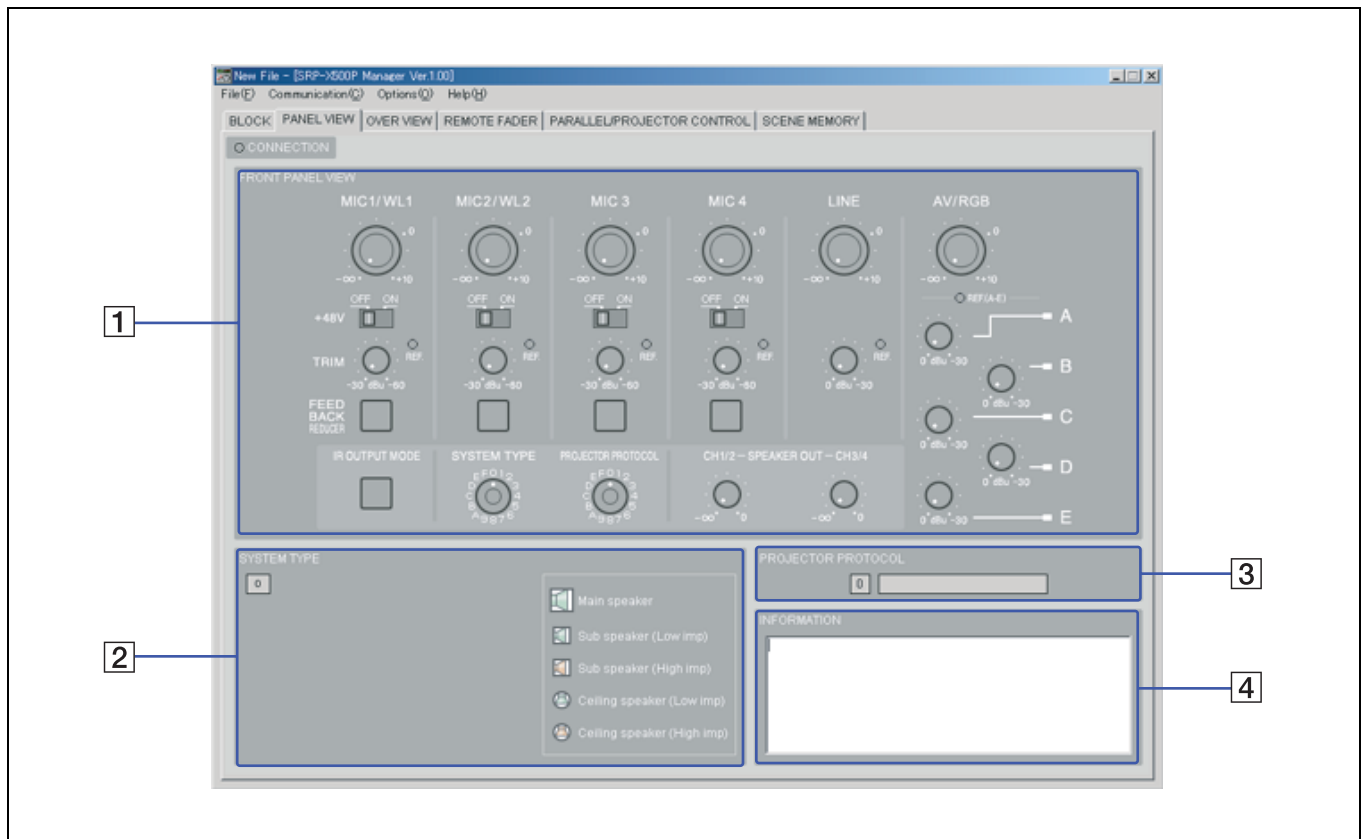
**1 FRONT PANEL VIEW display section**

Shows the settings performed through the front panel of the mixer.

If you save the current status of this section to the setup file, position of the controls and switches of the mixer can be recalled later. Then, by setting the controls and switches so that the markers representing them on the screen light up green, the front panel status can be easily reproduced.

2 SYSTEM TYPE display section

Shows the image of the system type specified by the SYSTEM TYPE selector on the front panel of the mixer.

3 PROJECTOR PROTOCOL display section

Displays the projector number specified by the PROJECTOR PROTOCOL selector on the front panel of the mixer and index name of the projector.

4 INFORMATION input section

Up to 128 alphanumeric characters can be entered.

OVER VIEW screen

The detailed settings on equalizer, automatic gain control, etc., for each channel can be performed.

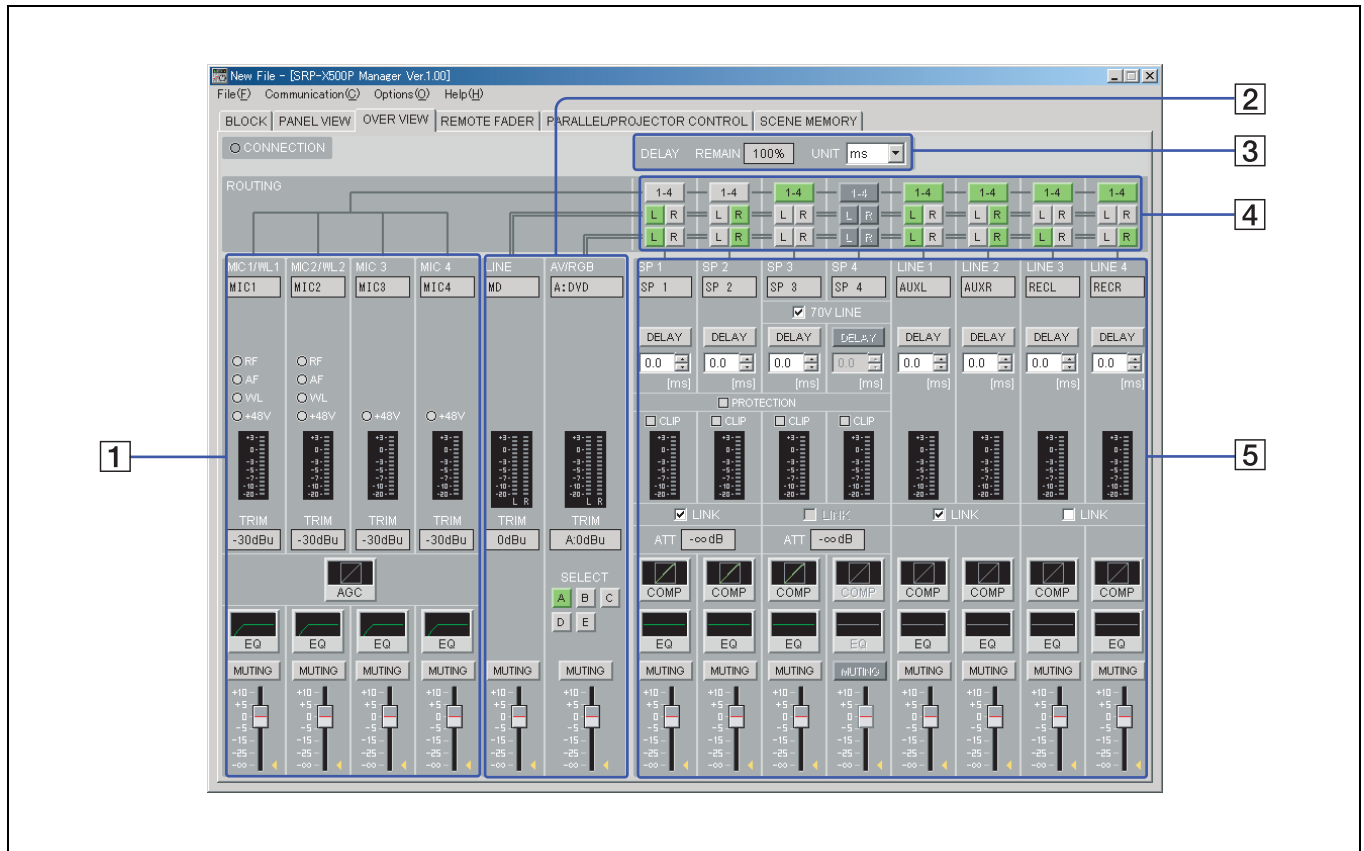

1 MIC INPUT setting section

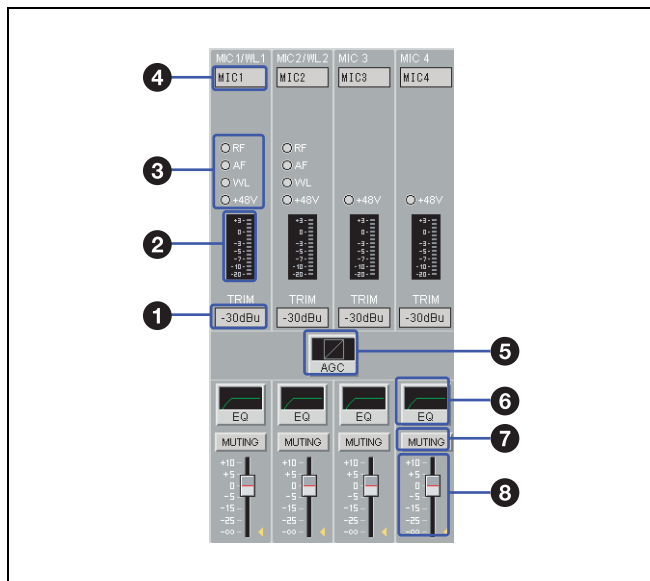

1 TRIM indication

Displays the reference level of the input channel specified by the TRIM control on the mixer within the range of -60 dBu to -30 dBu.

2 Level meter

Displays the signal level of the input channel.

3 Indicators

These are the indicators of microphone input.

RF: Lights up green when the RF signal is input to the wireless tuner unit which is installed in the mixer.

AF: Lights up yellow when the audio signal is input to the wireless tuner unit which is installed in the mixer.

WL: Lights up green when the signal is input to the mixer from the wireless tuner unit installed to the mixer. As long as this indicator is lit, the mixer selects the signal input from the wireless tuner unit.

+48V: Lights up red when the $+48$ V ON/OFF switch on the mixer is set to ON.

4 Index name indication

Shows the index name of the input channel entered in index name column of the BLOCK screen.

5 AGC (Automatic Gain Control) button

Left-click to display the AUTO GAIN CONTROL setting screen.

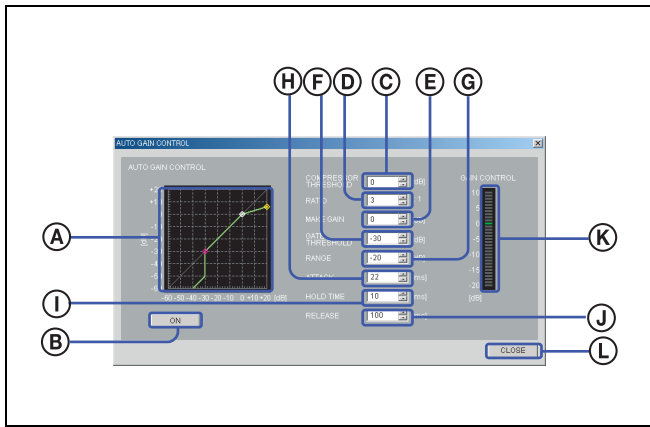

- A Characteristics graph**
Displays the characteristics of the automatic gain control. By dragging the marker with the mouse, threshold level and ratio of the compressor and threshold level of the gate can be changed.
- B ON button**
Click to turn the automatic gain control on or off. When set to on, this button lights up green.
- C COMPRESSOR THRESHOLD setup box**
Specifies the threshold level of the compressor. The level can be set within the range of -60 dB to $+20$ dB, in 1-dB steps.
- D RATIO setup box**
Specifies the ratio of the compressor. The value can be set within the range of 1 : 1 to ∞ : 1, in 14 steps.
- E MAKE GAIN setup box**
Specifies the make up gain value. The value can be set within the range of 0 dB to $+10$ dB, in 1-dB steps.
- F GATE THRESHOLD setup box**
Specifies the threshold level of the gate. The value can be set within the range of -60 dB to 0 dB, in 1-dB steps.
- G RANGE setup box**
Specifies the range of the gate. The value can be set within the range of -60 dB to 0 dB, in 1-dB steps.
- H ATTACK setup box**
Specifies the attack time. The value can be set within the range of 0.1 ms to 33000 ms, in 32 steps.
- I HOLD TIME setup box**
Specifies the hold time. The value can be set within the range of 0.1 ms to 33000 ms, in 32 steps.
- J RELEASE setup box**
Specifies the release time. The value can be set within the range of 0.1 ms to 33000 ms, in 32 steps.

- K GAIN CONTROL indication**
Shows the amount of gain control obtained by the AGC function.
- L CLOSE button**
Click to close the AUTO GAIN CONTROL setting screen.
- 6 FR/EQ (Feedback Reducer/Equalizer) button**
Left-click to display the MIC INPUT EQUALIZER setting screen.

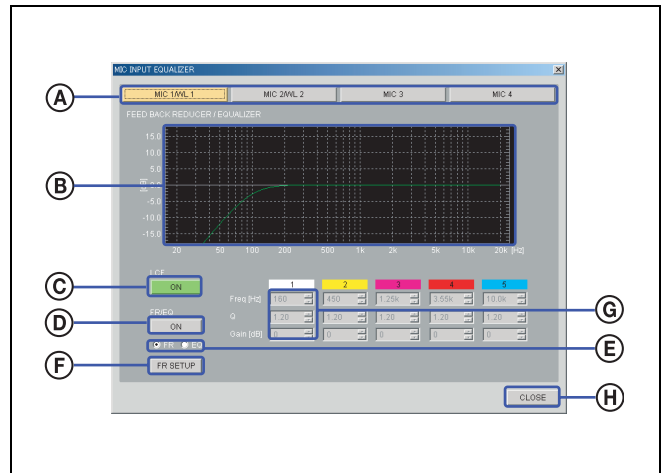

- A Channel selection button**
Selects the input channel that you want to set. The selected button lights up yellow. To select the other channel, left-click the corresponding button.
- B Equalizer pattern graph**
Appears when “EQ” is selected on the FR/EQ selection radio button. The markers with the same color as the corresponding band in the EQ parameter appear on the graph. You can change the gain and frequency for each band by dragging the corresponding marker with the mouse. Right-clicking the marker returns the gain to 0 dB. You can also change the Q value by rolling the center wheel of the mouse up or down.
- C LCF (low-cut filter) button**
Each click on this button toggles the low-cut filter between on and off. This button lights up green when set to on. The low-cut filter reduces low-frequency components such as blowing noise and makes the sound clearer.
- D FR/EQ button**
Each click on this button toggles the feedback reducer or equalizer between on and off. This button lights up green when set to on.
- E FR/EQ selection radio buttons**

Click “FR” or “EQ” to select the function of equalizer as the feedback reducer or the parametric equalizer.

FR: The feedback reducer setting screen appears.

When “FR” is selected, the EQ parameter 1 to 5 columns become inactive and FR SETUP button becomes active.

EQ: The 5-band parametric equalizer setting screen appears. When “EQ” is selected, the EQ parameter 1 to 5 columns become active and FR SETUP button becomes inactive.

Note

Changing the parametric equalizer setting will cancel the howling suppression. When you use the equalizer as the parametric equalizer, make the setting carefully not to affect the howling suppression.

F FR SETUP button

Left-click to display the channel selection dialog box. With the dialog box, select the channel and click OK button to carry out the automatic setting of the feedback reducer (function to suppress the positive acoustic feedback by detecting the frequency that causes howling in advance and by reducing the gain of the frequency).

Note

The FR SETUP button becomes operative only when the communication between the SRP-X500P Manager and the mixer is active and “FR” is selected on the FR/EQ selection radio buttons.

G EQ parameter setup boxes

Set the frequency, Q-value, and gain for each equalizer band. Values can be set by clicking on the Δ/∇ buttons or by entering numerical value directly.

H CLOSE button

Click to close the MIC INPUT EQUALIZER setting screen.

I MUTING button

Left-click to turn muting function on or off. The button lights up red when it is set to on.

J Input fader

You can adjust the input level by dragging the input fader. The yellow triangler marker displayed on the side of the fader indicates the fader position which is the sum of the input fader setting and the input level control settings on the mixer.

2 LINE, AV/RGB INPUT setting section

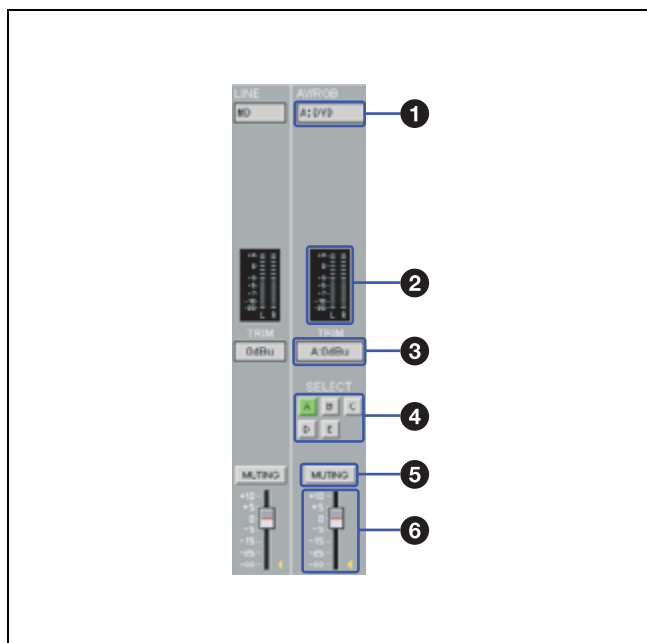

1 Index name indication

Shows the index name of the audio signal input from the LINE IN connectors or the AV/RGB INPUT connectors (A to E). For the signal input from the AV/RGB INPUT connectors, the index name is displayed along with the SELECT buttons indication (e.g., A:INDEX).

2 Level meters

Displays the signal level of each input channel.

3 TRIM indication

Displays the reference level of the input channel specified by the TRIM control on the mixer. For the signal input from the AV/RGB INPUT connectors, the reference level is displayed along with the SELECT buttons indication (e.g., A: -3 dB).

4 SELECT buttons

Click to select one of the AV/RGB channels (A to E). The button for the selected channel lights up green.

5 MUTING button

Left-click to turn muting function on or off. The button lights up red when it is set to on.

6 Input fader

You can adjust the input level by dragging the input fader. The yellow triangler marker displayed on the side of the fader indicates the fader position which is the sum of the input fader setting and remote fader setting on the software and the input level control settings on the mixer.

3 DELAY indication section

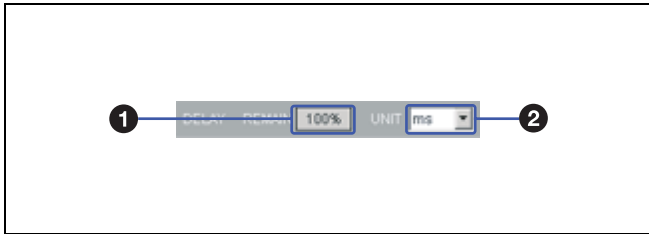

1 DELAY REMAIN indication

The total amount of delay time to be set for the total output channels must not exceed 160 ms (54.7 m, or 181.9 feet). After the DELAY REMAIN indication shows 0%, the amount of delay time cannot be increased.

2 UNIT setup box

Allows you to select the unit of the delay from the following: ms, meter, feet.

4 Routing setting section

With this section, you can select an output path for each input signal by assigning each input channel to an output channel.

The buttons on the first row are for the MIC INPUT channels. The buttons on the middle row are for the LINE INPUT L/R channels, and the buttons located on the last row are for the AV/RGB INPUT L/R channels.

Left-click a channel button to turn the corresponding channel on or off. Right-click the button to specify the sending level of the input signal to the output channel. When the channel button is set to on and the sending level is set to 0 dB, it lights up green. The button lights up blue when it is set to on and the sending level is set to -3 dB to -20 dB.

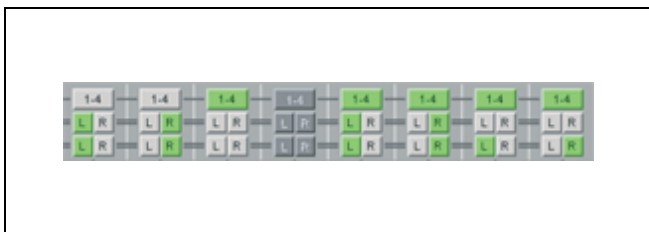

5 Output channels setting section

With this section, settings related to output channels can be performed.

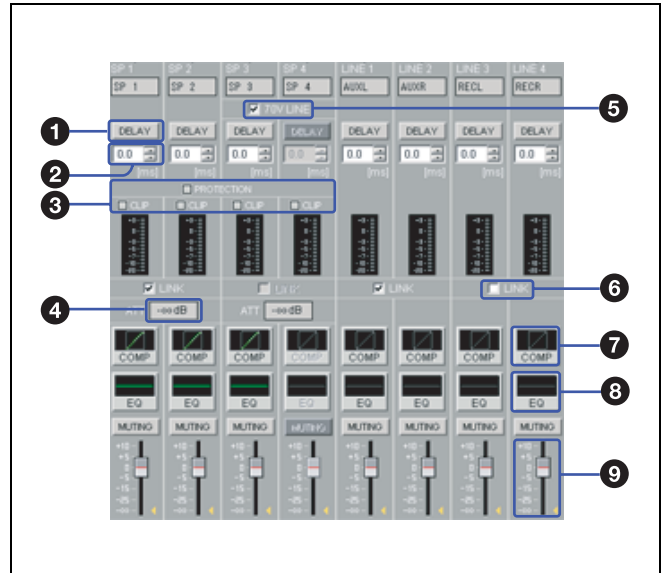

1 DELAY button

Turns the delay time function on or off. The button lights up green when the delay is turned to on.

2 DELAY amount setup box

Allows you to select the amount of delay. The value can be set by clicking on the \square/\square buttons or by entering numerical value directly. The amount of delay is shown in units specified in the UNIT setup box on the DELAY indication section.

Note

The total amount of delay time to be set for the total output channels must not exceed 160 ms (54.7 m, or 181.9 feet). Determine the amount of delay time by watching the DELAY REMAIN indication on the DELAY indication section.

3 Speaker output indicators

PROTECTION: Lights up red when the PROTECTION indicator on the mixer lights up red.

CLIP: Lights up red when the CLIP indicator on the mixer lights up red.

4 ATT indication

Shows the attenuation level specified by the SPEAKER OUT controls on the mixer.

5 70V LINE check box

Check to set the SPEAKER 3 and 4 channels to 70V LINE.

6 LINK check box

Check the parameter settings for the SPEAKER 1 and 2, SPEAKER 3 and 4, LINE 1 and 2, or LINE 3 and 4 to link with each other.

Notes

- Even when the LINK check box is checked, equalizer settings are not linked between the 2 channels.
- When the sum of delay amount or compressor amount exceeds the limit due to linkage of the 2 channels, a warning message appears. If this occurs, reduce the amount.

7 COMP button

Left-click to display the COMPRESSOR setting screen.

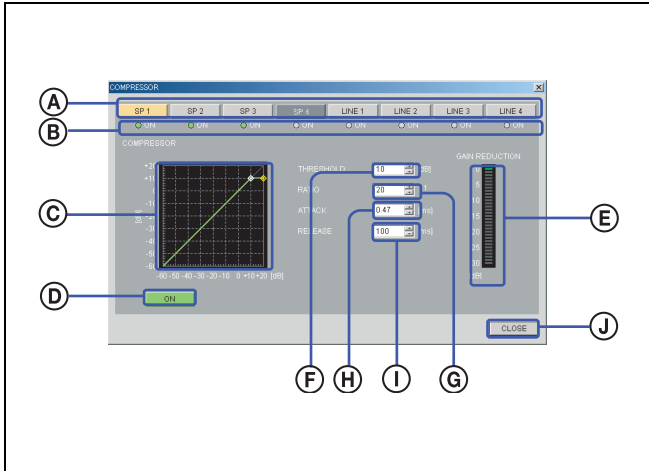

- A Channel selection buttons**
The selected button lights up yellow. To select the other channel, left-click the corresponding button.
- B ON indicator**
The indicator for the channel whose compressor setting is turned on lights up green.
- C Characteristics graph**
Displays the characteristics of the compressor. By dragging the markers with the mouse, threshold level and ratio of the compressor can be changed.
- D ON button**
Left-click to turn the compressor on or off. When set to on, this button lights up green.

Note

Compressor can be simultaneously applied to up to 4 output channels.

- E GAIN REDUCTION indicator**
Shows the amount of attenuation of the gain.
- F THRESHOLD setup box**
Specifies the threshold level of the compressor.
- G RATIO setup box**
Specifies the ratio of the compressor.

- H ATTACK setup box**
Specifies the attack time.
- I RELEASE setup box**
Specifies the release time.

- J CLOSE button**
Click to close the COMPRESSOR setting screen.

8 EQ button

Left-click to display the OUTPUT EQUALIZER setting screen.

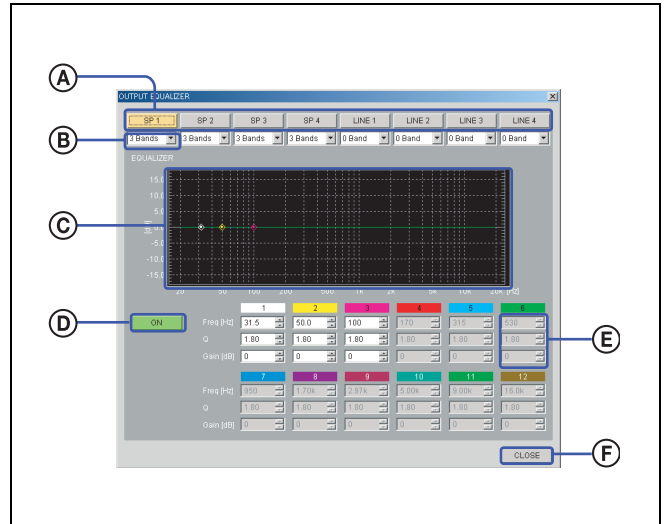

- A Channel selection buttons**
The selected button lights up yellow. To select the other channel, left-click the corresponding button.
- B Number of bands setup box**
Use the pull-down menu to select the number of bands to set the parameters. 0, 3, 6, 9, or 12 bands can be selected. The parameter setup boxes corresponding to the selected number of bands become active.

Note

The total amount of equalizer bands to be applied to the total output channels must not exceed 24 bands. While setting the equalizer for the output channels, be sure that the total number of equalizer bands is 24 or less.

- C Equalizer pattern graph**
The markers with the same color as the corresponding band in the EQ parameter appear on the graph. You can change the gain and frequency for each band by dragging the corresponding marker with the mouse. Right-clicking the marker returns the gain to 0 dB. You can also change the Q value by rolling the center wheel of the mouse up or down.
- D ON button**

Left-click to turn the equalizer on or off. When set to ON, this button lights up green.

E Equalizer parameter setup boxes

Set the frequency, Q-value, and gain for each equalizer band. Values can be set by clicking on the Δ/∇ buttons or by entering numerical value directly.

F CLOSE button

Click to close the OUTPUT EQUALIZER setting screen.

9 Output fader

You can adjust the output level by dragging the output fader. The yellow triangular marker displayed on the side of the fader indicates the fader position which is the sum of the output fader setting, remote fader setting, and the output level control settings on the mixer.

For details on the index name indication, level meters, and the MUTING button, see “1 MIC INPUT setting section” of the OVER VIEW screen (page 10).

REMOTE FADER screen

By assigning input/output faders to the remote faders, you can control the volume of assigned channels with single fader operation.

The level of the MASTER fader can be controlled by the MASTER volume control on the front panel of the mixer.

The level of the REMOTE 1 to 6 faders can be controlled through the REMOTE PARALLEL connector on the rear panel of the mixer.

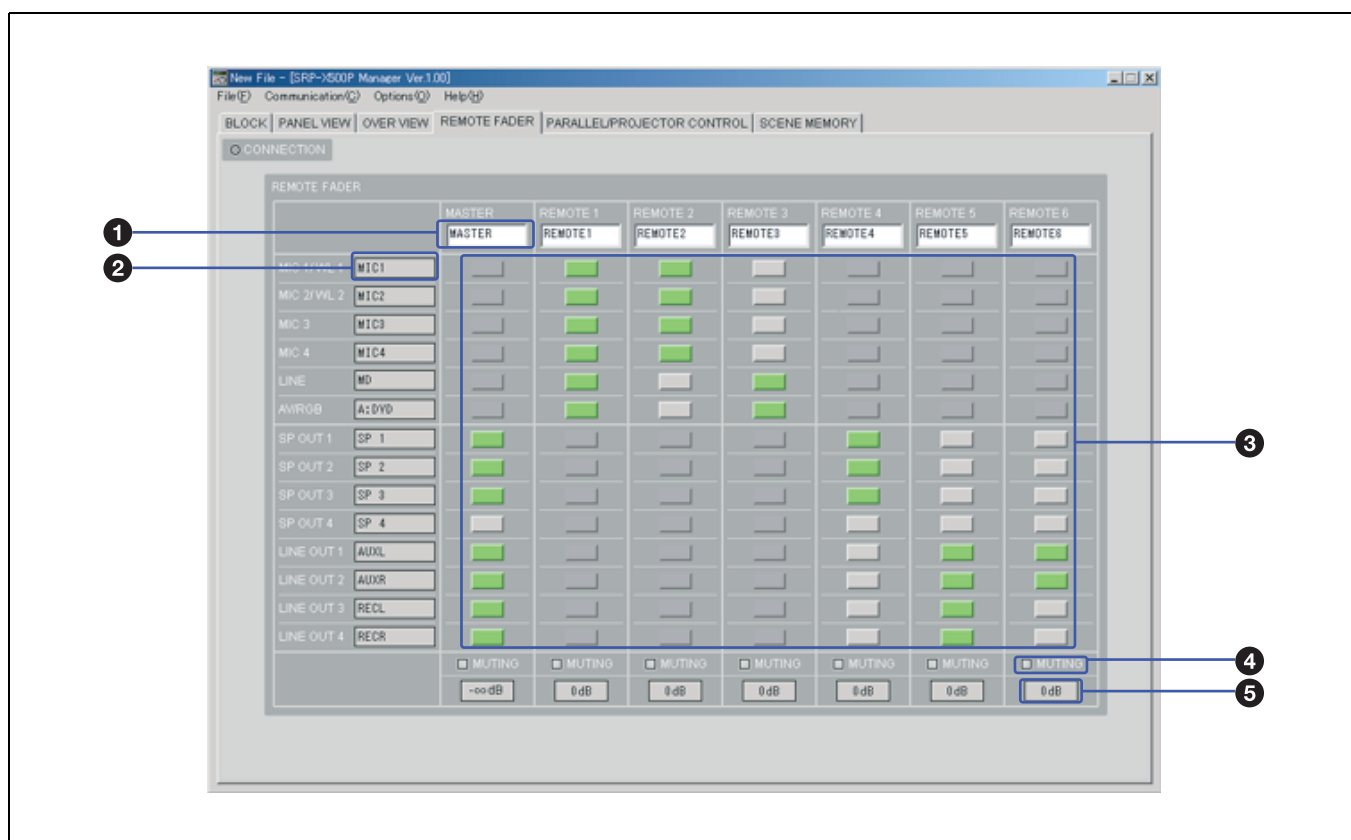

1 Index name input box

You can enter an index name for each remote fader. Up to eight alphanumeric characters can be entered.

2 Index name indication

Displays the index name entered in the BLOCK setting screen.

3 Fader assignment buttons

Left-click the button to assign input/output faders to the remote fader. The buttons corresponding to assigned input/output faders light up green.

Note

Input faders and output faders cannot be assigned to the same remote fader.

4 MUTING indicator

The indicator for the muted fader lights up red.

5 Remote fader level indication

Shows the level of the remote fader.

PARALLEL/PROJECTOR CONTROL screen

The PARALLEL/PROJECTOR CONTROL screen allows you to make settings on the REMOTE PARALLEL connector of the mixer and projector control.

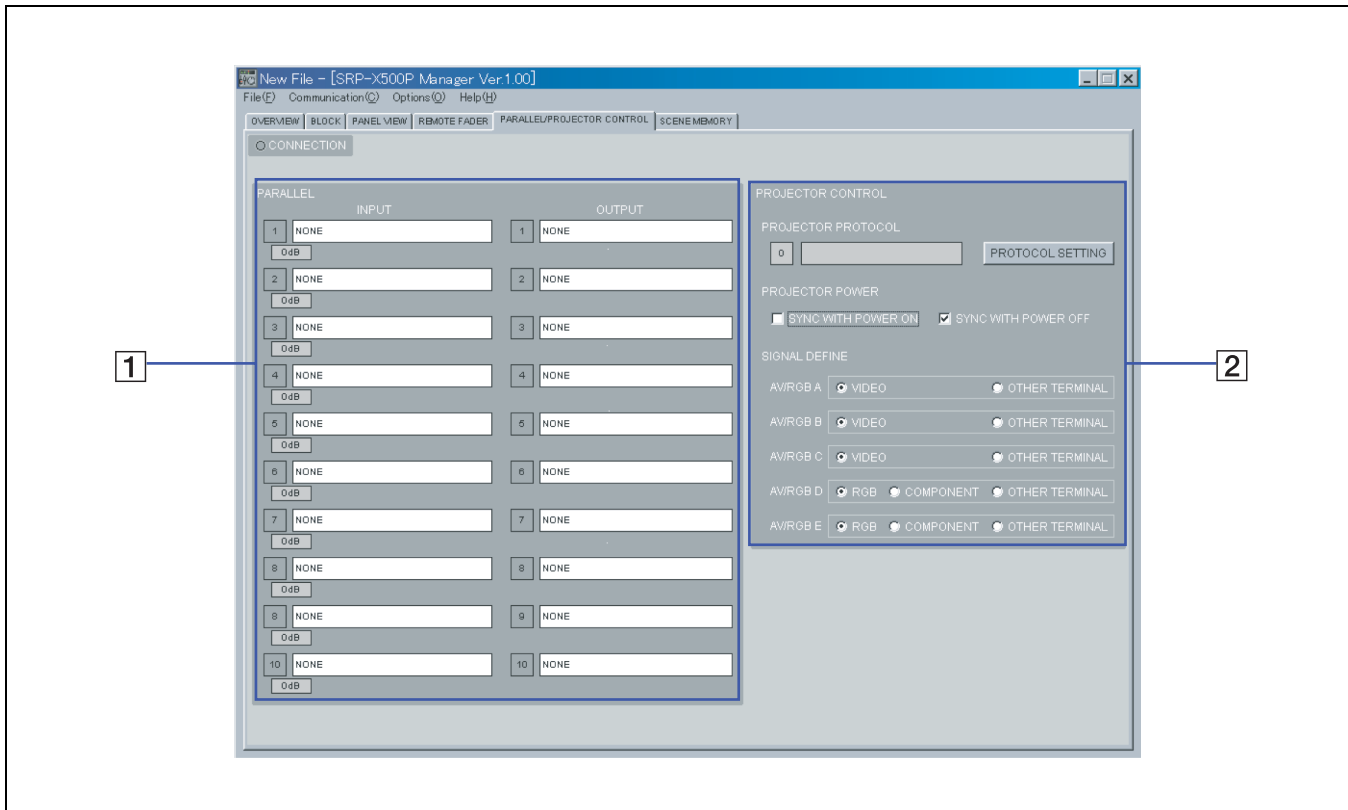

1 PARALLEL setting section

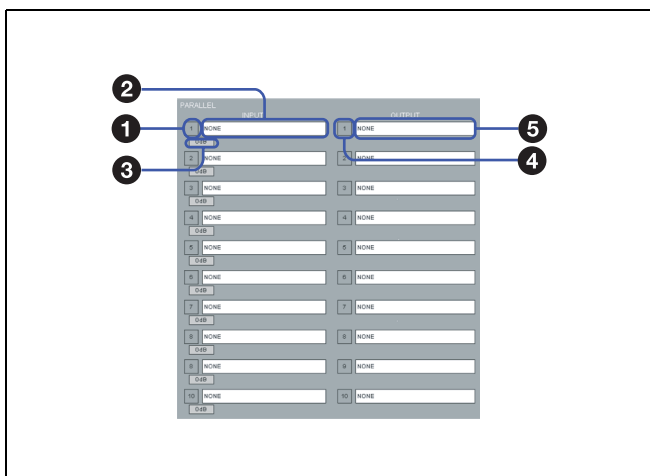

1 PARALLEL INPUT indicators

Show the status of each input pin of the REMOTE PARALLEL connector.

When input voltage is high: Turns off.

When input voltage is low: Lights up green.

2 INPUT function selection section

Left-click and select the function from the pull-down menu.

The selectable functions are as follows:

INPUT		Connectable device	Function
NONE		-	None
AV/RGB SELECT	OFF, A-E	Switch (momentary type)	When turned on, selects AV/RGB SELECT setting (OFF or A-E).
MASTER VOLUME	MUTING	Switch (latch type)	When turned on, mutes the master volume. Turn off to cancel muting.
	UP	Switch (momentary type)	While turned on, keeps turning up the master volume.
	DOWN	Switch (latch type)	While turned on, keeps turning down the master volume.
REMOTE FADER 1-6	MUTING	Switch (latch type)	When turned on, mutes the remote fader. Turn off to cancel muting.
	LEVEL	Volume	Adjusts the remote fader volume.

SCENE RECALL	1-8	Switch (momentary type)	When turned on, recalls the scene memory.
PROJECTOR POWER	ON	Switch (momentary type)	When turned on, turns on the projector power.
	STANDBY	Switch (momentary type)	When turned on, sets the projector to standby status.
	ON/STANDBY	Switch (latch type)	When turned on, turns on the projector power. Turn off to set the projector to standby status.
EMG	OPEN	Emergency broadcast system	When the signal from the emergency broadcast system is OPEN, mutes all output channels. Turn off to cancel muting.
	CLOSE	Emergency broadcast system	When the signal from the emergency broadcast system is CLOSE, mutes all output channels. Turn off to cancel muting.

3 Input level indication

Shows the input level setting on the mixer. This is indicated only when a volume controller is connected to the input pin.

4 PARALLEL OUTPUT indicators

Show the status of each output pin of the REMOTE PARALLEL connector.

When output voltage is low: Lights up green.

When output voltage is high: Turns off.

5 OUTPUT function selection section

Left-click and select the function from the pull-down menu.

The selectable functions are as follows:

OUTPUT		Function
NONE		None
AV/RGB SELECT	OFF, A-E	Turns on (Low) when the corresponding channel is SELECT.
MASTER VOLUME	MUTING	Turns on (Low) when the master volume is fully turned down.
	MAX (UP)	Turns on (Low) when the master volume is at the maximum level.
	MIN (DOWN)	Turns on (Low) when the master volume is at the minimum level.
REMOTE FADER 1-6	MUTING	Turns on (Low) when the corresponding remote fader is fully turned down.
	MAX	Turns on (Low) when the corresponding remote fader is at the maximum level.
	MIN	Turns on (Low) when the corresponding remote fader is at the minimum level.
SCENE RECALL	1-8	Turns on (Low) when the corresponding scene memory is recalled.
PROJECTOR POWER	ON	Turns on (Low) when the projector is turned on.
	STANDBY	Turns on (Low) when the projector enters standby status.
EMG		Turns on (Low) when all output channels are muted by the EMG setting for the input pins (either OPEN or CLOSE).

2 PROJECTOR CONTROL setting section

With this section, settings related to projector control can be performed.

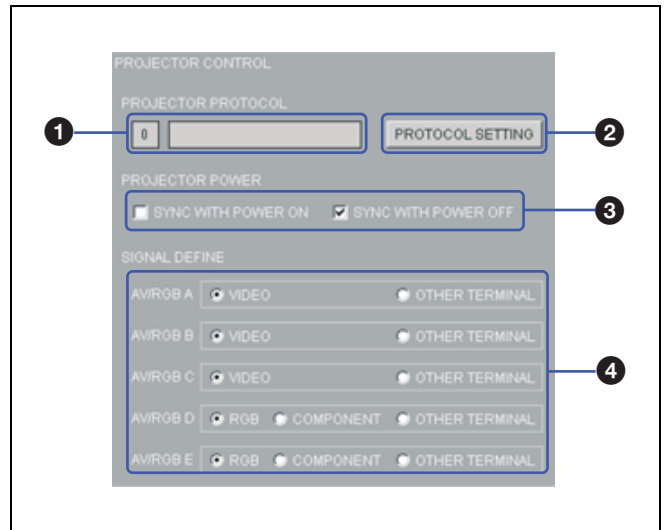

1 PROJECTOR PROTOCOL indication

Shows the status of the PROJECTOR PROTOCOL selector setting on the mixer and the name of the projector.

2 PROTOCOL SETTING button

Left-click to display the PROTOCOL SETTING screen.

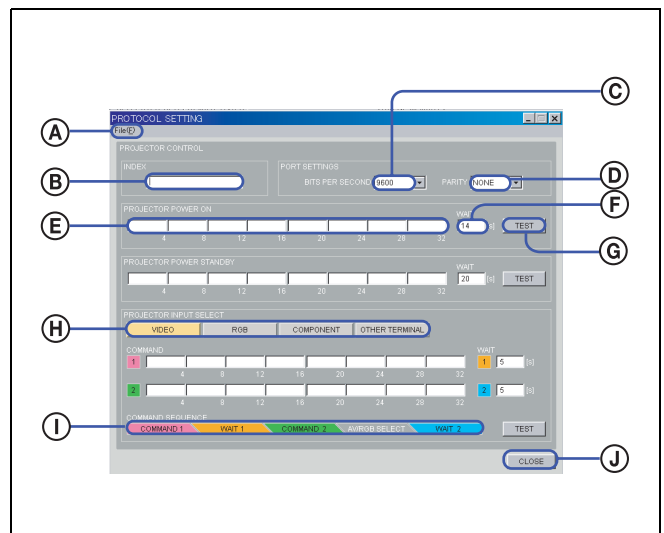

A File menu

The projector protocol settings can be saved as a file and can be recalled later.

B INDEX name input box

You can enter an index name the projector protocol setting file. Up to 16 alphanumeric characters can be entered.

C BITS PER SECOND setup box

Use the pull-down menu to select the baud rate for the RS-232C port for projector control.

D PARITY setup box

Use the pull-down menu to select the parity bits.

Ⓔ Command input section

Enter the commands to be sent from the mixer to the projector to turn it on, to set it to standby status, or to select the input channel. Enter the command as a hexadecimal number using numbers 0 to 9 and letters A to F.

The maximum length of the command is 32 bytes.

Ⓕ WAIT input box

Specify the wait time until the another command is sent after the projector has received the previously sent command.

Ⓖ TEST button

Press to run the test on sending command.

Ⓗ PROJECTOR INPUT SELECT buttons

Press one of the buttons to select the signal format, then enter the command defining the input channel on the projector for the signal format.

Ⓛ COMMAND SEQUENCE indication

Shows the sequence of commands and the wait time to be sent for defining the input channel on the projector.

Ⓜ CLOSE button

Click to close the PROTOCOL SETTING setting screen.

Ⓝ PROJECTOR POWER setting section

By checking the SYNC WITH POWER ON checkbox, you can interlock the power on/off control of the projector with the POWER switch operation on the SRP-X500P.

Ⓖ SIGNAL DEFINE selection radio buttons

Click to select the format of the video signal which is input to each of the AV/RGB INPUT connectors.

SCENE MEMORY screen

You can store the settings that you usually use as a scene file to internal memory of the mixer to recall it whenever

you use it. Or, by storing scene files in advance, you can quickly deal with division of the room.

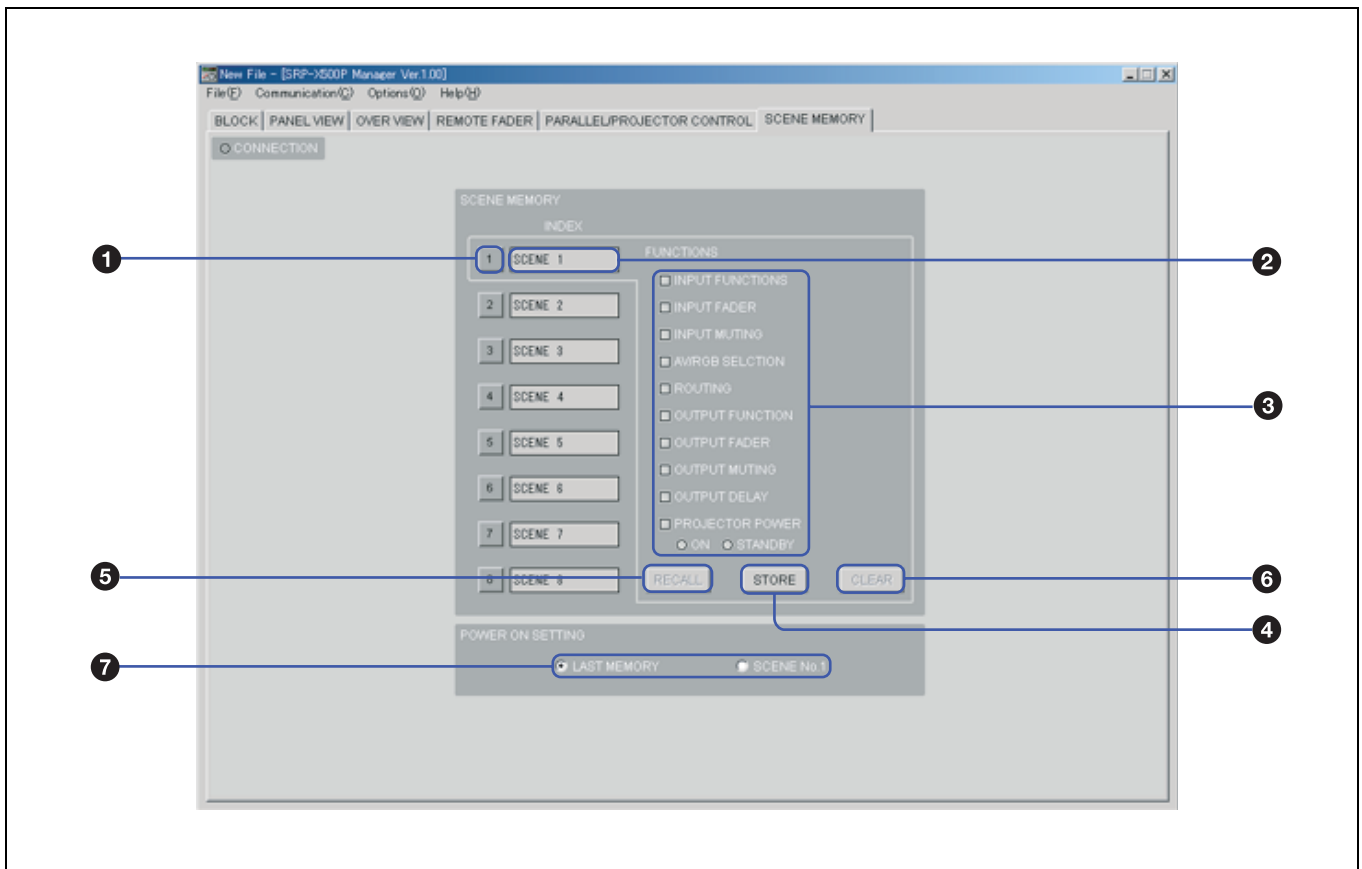

Ⓛ SCENE MEMORY button

Left-click to select the scene file number.

The color of the button shows the status of the scene file number.

Green: Currently selected.

Gray: A scene file is stored.

Deep gray: No scene file is stored.

② INDEX indication

Shows the index name of the scene file.

③ FUNCTIONS indication

The functions stored to the selected scene file light up green.

④ STORE button

Used to store the scene file. Left-click to display the setting screen to allow entering the index name and selecting the functions to be included in the scene file.

⑤ RECALL button

Click to recall the scene file whose number is currently selected by the SCENE MEMORY button. This button does not work when you have selected a number with no scene file is stored.

⑥ CLEAR button

Click to clear the scene file whose number is currently selected by the SCENE MEMORY button. This button does not work when you have selected a number with no scene file is stored.

⑦ POWER ON SETTING radio buttons

Click to select the scene file status to be automatically recalled when the mixer is turned on.

LAST MEMORY: The status when the power to the mixer has been turned off resumes.

SCENE No.1: The scene file No.1 is recalled.

About the Mixer's Internal Preset Memory

SYSTEM TYPE preset memory

By setting the SYSTEM TYPE selector on the front panel of the mixer to 1 to 9, you can choose the speaker system type setting that corresponds with the AV system being used.

Of the items included in the system type preset memory 1 to 9, the setting of the following items cannot be changed using the SRP-X500P Manager.

- MIC INPUT Low Cut Filter
- MIC INPUT FR/EQ settings
- INPUT fader
- INPUT MUTING
- ROUTING
- Number of bands of the OUTPUT equalizer
- OUTPUT compressor
- OUTPUT fader
- OUTPUT MUTING
- OUTPUT LINK
- DELAY
- 70V LINE/Lo imp. setting for the SPEAKERS CH-3/4 terminals
- REMOTE FADER
- Scene memory

To change the setting of the items above, set the SYSTEM TYPE selector on the mixer to "0", turn off the mixer, and then turn it on again.

For details on the settings other than the REMOTE FADER, refer to the Operating Instructions supplied with the mixer.

The preset patterns for the REMOTE FADER are shown in the following table:

SYSTEM TYPE	Setting	Setting						
		MASTER	REMOTE					
			1	2	3	4	5	6
1	MIC 1-4	-	○	○	-	-	-	-
	LINE, AV/RGB	-	○	-	○	-	-	-
	SP OUT 1	○	-	-	-	○	-	-
	SP OUT 2	○	-	-	-	○	-	-
	SP OUT 3	○	-	-	-	○	-	-
	SP OUT 4	-	-	-	-	-	-	-
	LINE OUT 1	○	-	-	-	-	○	○
	LINE OUT 2	○	-	-	-	-	○	○
	LINE OUT 3	-	-	-	-	-	○	-
	LINE OUT 4	-	-	-	-	-	○	-
2	MIC 1-4	-	○	○	-	-	-	-
	LINE, AV/RGB	-	○	-	○	-	-	-
	SP OUT 1	○	-	-	-	○	-	-
	SP OUT 2	○	-	-	-	○	-	-
	SP OUT 3	○	-	-	-	○	-	-
	SP OUT 4	○	-	-	-	○	-	-
	LINE OUT 1	○	-	-	-	-	○	○
	LINE OUT 2	○	-	-	-	-	○	○
	LINE OUT 3	-	-	-	-	-	○	-
	LINE OUT 4	-	-	-	-	-	○	-
3	MIC 1-4	-	○	○	-	-	-	-
	LINE, AV/RGB	-	○	-	○	-	-	-
	SP OUT 1	○	-	-	-	○	-	-
	SP OUT 2	○	-	-	-	○	-	-
	SP OUT 3	-	-	-	-	-	-	-
	SP OUT 4	-	-	-	-	-	-	-
	LINE OUT 1	○	-	-	-	-	○	○
	LINE OUT 2	○	-	-	-	-	○	○
	LINE OUT 3	-	-	-	-	-	○	-
	LINE OUT 4	-	-	-	-	-	○	-

4	MIC 1-4	-	○	○	-	-	-	-
	LINE, AV/RGB	-	○	-	○	-	-	-
	SP OUT 1	-	-	-	-	-	-	-
	SP OUT 2	-	-	-	-	-	-	-
	SP OUT 3	○	-	-	-	○	-	-
	SP OUT 4	-	-	-	-	-	-	-
	LINE OUT 1	○	-	-	-	-	○	○
	LINE OUT 2	○	-	-	-	-	○	○
	LINE OUT 3	-	-	-	-	-	○	-
5	MIC 1-4	-	○	○	-	-	-	-
	LINE, AV/RGB	-	○	-	○	-	-	-
	SP OUT 1	○	-	-	-	○	-	-
	SP OUT 2	○	-	-	-	○	-	-
	SP OUT 3	○	-	-	-	○	-	-
	SP OUT 4	○	-	-	-	○	-	-
	LINE OUT 1	○	-	-	-	-	○	○
	LINE OUT 2	○	-	-	-	-	○	○
6-9	MIC 1-4	-	○	○	-	-	-	-
	LINE, AV/RGB	-	○	-	○	-	-	-
	SP OUT 1	○	-	-	-	○	-	-
	SP OUT 2	○	-	-	-	○	-	-
	SP OUT 3	○	-	-	-	○	-	-
	SP OUT 4	○	-	-	-	○	-	-
	LINE OUT 1	○	-	-	-	-	○	○
	LINE OUT 2	○	-	-	-	-	○	○

○ : Assigned.
- : Not assigned.

PROJECTOR PROTOCOL preset memory

By setting the PROJECTOR PROTOCOL selector on the front panel of the mixer to 1 to A, you can choose the protocol that corresponds with the projector or display monitor to be used with the mixer.

Of the items included in the protocol 1 to A, the setting of the following items cannot be changed using the SRP-X500P Manager.

- Index

- Baud rate
- Parity bit
- POWER ON and STANDBY commands and the wait time
- VIDEO, RGB, and COMPONENT input selection command and the wait time

The input selection command for OTHER TERMINAL is not preset to the mixer.

When you input S-video signal or etc. from the video source device directly to the projector or display monitor, specify the input command.

For details on the projector or display monitor whose protocol is preset to the mixer, refer to the Operating Instructions supplied with the mixer.

To Control the Projector Whose Protocol Is Not Preset to the Mixer

Set the PROJECTOR PROTOCOL selector on the mixer to “0”, turn off the mixer, then turn it on again.

And then, make the necessary settings in the PROTOCOL SETTING screen.

Connectable projectors

Projectors which satisfy the following specifications can be connected to the mixer.

- Equipped with RS-232C remote terminal
- Equipped with the RS-232C remote terminal supporting the following specifications:
 - Electrical characteristics : Conforming to RS-232C
 - Baud rate : 9600, 19200 or 38400 bps
 - Parity bit : None, odd or even
 - Data length : 8 bits
 - Stop bit : 1 bit
 - Flow control : None

The RS-232C remote terminal can be used to turn on the power, turn off the power, and select the input terminal.

Video signal systems and limitations

This system has the following limitations depending on the video signal system used and on the operation method. The limitations are shown below.

- **When component signal is used**

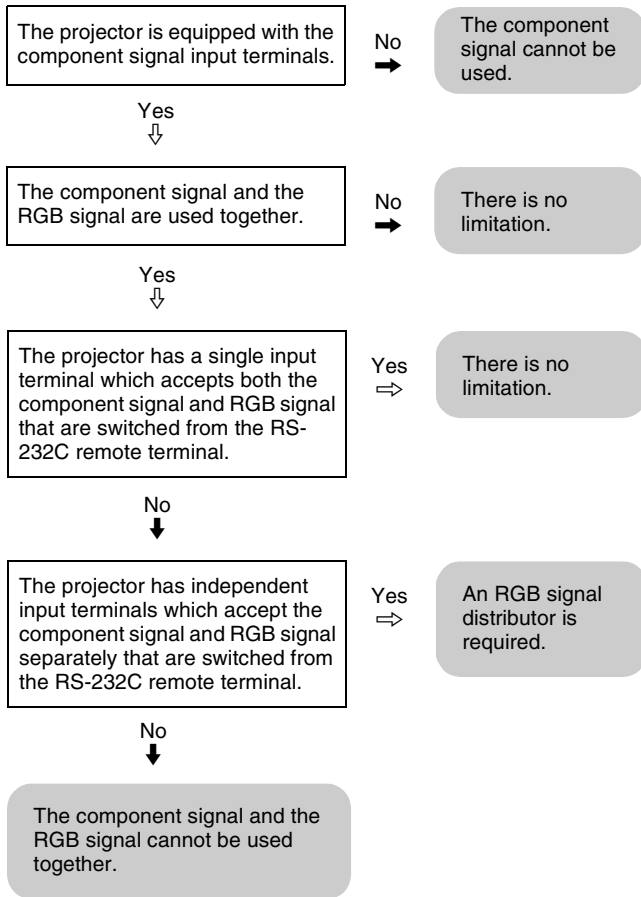

Connecting to projector

For details on connecting the mixer to a projector, refer to the SRP-X500P Operating Instructions.

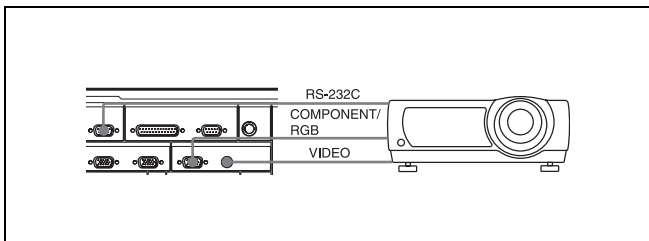

How to set the communication protocol

Set the communication protocol as follows.

1 Settings for the port

Set the BITS PER SECOND setup box and the PARITY setup box in accordance with the specifications of the projector.

2 Settings for command to turn on the projector

- 1 Enter the command to turn on the projector connected to the mixer in the command input section of the PROTOCOL SETTING screen.
- 2 Enter 60 seconds in the WAIT input box, then adjust the wait time during later operation check.

Note

If the commands that can be received by the projector are specified as ASCII code, convert the ASCII code to a hexadecimal number and enter it in the command input section.

3 Settings for command to set the projector to standby status

- 1 Enter the command to set the projector connected to the mixer to standby status in the command input section of the PROTOCOL SETTING screen.
- 2 Enter 100 seconds in the WAIT input box, then adjust the wait time during later operation check.

4 Settings for command to define the input signal

- 1 Click one of the PROJECTOR INPUT SELECT buttons to specify the signal format, then enter the command in the command input section as follows:

When the projector input can be selected by sending a single command

Enter the input signal selection command to the COMMAND 1 line. Leave the COMMAND 2 line blank.

When the signal format selection command and input terminal selection command are required

Enter the signal format selection command to the COMMAND 1 line, then enter the input terminal selection command to the COMMAND 2 line.

Setting example

When the signal systems of VIDEO, COMPONENT and RGB are used, and when a single command is required for the VIDEO input selection while both commands are required for the COMPONENT and RGB input signal selection, set as shown below.

Signal format	COMMAND1	COMMAND2
VIDEO	VIDEO input terminal selection command	Undefined (blank)
RGB	RGB signal selection command	COMPONENT/RGB input terminal select command

COMPONENT	COMPONENT signal selection command	COMPONENT/RGB input terminal select command
OTHER TERMINAL	Undefined (blank)	Undefined (blank)

- ② Enter 1 in the WAIT1 input box and enter 9 in the WAIT2 input box, then adjust the wait time during later operation check.

5 Operation check by using the TEST button

- ① Select VIDEO using the PROJECTOR INPUT SELECT button without inputting any signals to AV/RGB INPUT connectors of the mixer, then click the TEST button on the PROTOCOL SETTING screen.
- ② Check that VIDEO is selected as the input signal on the projector.
- ③ Do steps ① and ② for all other signal formats.

If the input selection on the projector is not performed correctly, check that the commands entered in the command input section and the port setting are correct.

After confirming the commands and the port setting, repeat the step 5 above by increasing the wait time to be input to the WAIT1 input box in 1-second steps until the projector operates correctly.

6 Operation check by using the AV/RGB SELECT buttons on the mixer

- ① Click one of the SIGNAL DEFINE selection radio buttons on the PARALLEL/PROJECTOR CONTROL screen to make the setting for actual use.
- ② Input signals from all the AV/RGB INPUT connectors on the mixer, and press the AV/RGB SELECT buttons on the mixer to check that the video signal is output to the projector.
- ③ Press the AV/RGB SELECT buttons to check all operation patterns (A → B, A → C, A → D, A → E, E → A, E → B, E → C, and E → D) to check that the video signal is output to the projector.
- ④ Press the AV/RGB SELECT buttons several times at random to check that the video signal corresponding to the button which has been pressed the last is output to the projector.
- ⑤ Repeat the step ④ more than ten times.

When the video signal is not output to the projector, check the settings of the SIGNAL DEFINE selection

radio buttons on the PARALLEL/PROJECTOR CONTROL screen and the settings on the projector. After confirming the settings above are correct, do the steps below to adjust the wait time.

- ① Increase the wait time to be input to the WAIT1 and 2 input boxes at the same time in 1-second steps until the projector operates correctly.
- ② Decrease the wait time to be input to the WAIT1 input box in 1-second steps until the projector operates correctly.
- ③ Decrease the wait time to be input to the WAIT2 input box in 1-second steps until the projector operates correctly.

If you want to shorten the time to take for the video signal is output to the projector after pressing the AV/RGB SELECT buttons on the mixer, set the wait time for the WAIT1 and 2 input boxes to the shortest time first. Then perform “5 Operation check by using the TEST button” and “6 Operation check by using the AV/RGB SELECT buttons on the mixer”.

7 Operation check to turn on the projector

- ① Press the AV/RGB SELECT A button on the mixer and check that the video signal is output to the projector.
- ② Operate the input signal selector on the projector so that no video signal is output to the projector.
- ③ Press the POWER switch on the projector to place it to standby status.
- ④ After confirming that the projector is in standby status, click the TEST button in the PROJECTOR POWER ON section on the PROTOCOL SETTING screen.
- ⑤ Check that the projector turns on and the video signal output to the AV/RGB INPUT connector is input to the projector.
- ⑥ Repeat the steps ① to ⑤ for the AV/RGB SELECT B-E buttons.

When the projector does not turn on, check that the command entered in the command input section is correct.

When the video signal is not output to the projector, repeat the test by increasing the wait time to be input to the WAIT input box in 1-second steps until the projector operates correctly.

If you want to shorten the time to take for the video signal is output after the projector turns on, repeat the test by decreasing the wait time to be input to the WAIT input box in 1-second steps until the projector operates correctly.

8 Operation check to set the projector to standby status

- ❶ Click the TEST button in the PROJECTOR POWER STANDBY section on the PROTOCOL SETTING screen and check that the projector enters standby status.
- ❷ Click the TEST button in the PROJECTOR POWER ON section and check that the projector turns on.
- ❸ Press the AV/RGB SELECT A button on the mixer and check that the video signal is output to the projector.
- ❹ Click the TEST button in the PROJECTOR POWER STANDBY section, then after about 3 seconds, click the TEST button in the PROJECTOR POWER ON section.
- ❺ Check that the projector enters standby status.
- ❻ Check that the projector turns on after the wait time specified by the WAIT input box elapses and the video signal output to the AV/RGB INPUT A connector is input to the projector.

When the projector does not enter standby status, check that the command entered in the command input section is correct.

When the projector does not turn on, repeat the test by increasing the wait time to be input to the WAIT input box in 1-second steps until the projector operates correctly.

Appendix

Factory settings (SYSTEM TYPE 0)

Inputs

Item		Factory setting
MIC INPUT1-4	FEED BACK REDUCER ON / OFF	OFF
	FR / EQ	FR
	LCF	ON
	EQ1 FREQ	160Hz
	EQ2 FREQ	450Hz
	EQ3 FREQ	1.25kHz
	EQ4 FREQ	3.55kHz
	EQ5 FREQ	10kHz
	EQ1-5 Q	1.2
	EQ1-5 GAIN	0dB
	INPUT FADER	0dB
	INPUT MUTING	OFF
	LINE IN L,R	INPUT FADER
INPUT MUTING		OFF
AV/RGB IN A-E	INPUT FADER	0dB
	INPUT MUTING	OFF
	SELECTOR	A
INDEX	MIC 1 INPUT INDEX	MIC 1
	MIC 2 INPUT INDEX	MIC 2
	MIC 3 INPUT INDEX	MIC 3
	MIC 4 INPUT INDEX	MIC 4
	LINE INPUT INDEX	MD
	AV/RGB INPUT A INDEX	DVD
	AV/RGB INPUT B INDEX	VTR
	AV/RGB INPUT C INDEX	CASSETTE
	AV/RGB INPUT D INDEX	PC 1
	AV/RGB INPUT E INDEX	PC 2
MIC MIX BUS	AGC ON / OFF	OFF
	AGC COMPRESSOR THRESHOLD	0dB
	AGC RATIO	3:1
	AGC MAKE GAIN	0dB
	AGC GATE THRESHOLD	-30dB
	AGC RANGE	-20dB
	AGC ATTACK	22ms
	AGC HOLD TIME	10ms
	AGC RELEASE	100ms

Outputs

Item	Factory setting
SPEAKERS CH-1/2 OUTPUT FADER	0dB
OUTPUT MUTING	OFF
EQ BAND	3 BAND
EQ ON / OFF	OFF
EQ1 FREQ	31.5Hz
EQ2 FREQ	50Hz
EQ3 FREQ	100Hz
EQ4 FREQ	170Hz
EQ5 FREQ	315Hz
EQ6 FREQ	530Hz
EQ7 FREQ	950Hz
EQ8 FREQ	1.7kHz
EQ9 FREQ	2.97kHz
EQ10 FREQ	5kHz
EQ11 FREQ	9kHz
EQ12 FREQ	16kHz
EQ1-12 Q	1.8
EQ1-12 GAIN	0dB
COMPRESSOR ON / OFF	ON
COMPRESSOR THRESHOLD	10dB
COMPRESSOR RATIO	∞ : 1
COMPRESSOR ATTACK	0.47ms
COMPRESSOR RELEASE	100ms
DELAY ON/OFF	OFF
DELAY TIME	0ms
OUTPUT LINK ON / OFF	ON

SPEAKERS CH-3/4	OUTPUT FADER	0dB
	OUTPUT MUTING	OFF
	EQ BAND	3 BAND
	EQ ON / OFF	ON:CH-3 OFF:CH-4
	EQ1 FREQ	31.5Hz
	EQ2 FREQ	63Hz
	EQ3 FREQ	150Hz
	EQ4 FREQ	315Hz
	EQ5 FREQ	710Hz
	EQ6 FREQ	1.5kHz
	EQ7 FREQ	3.35kHz
	EQ8 FREQ	7.5kHz
	EQ9 FREQ	16kHz
	EQ10-12 FREQ	20kHz
	EQ1-12 Q	1.5
	EQ1-12 GAIN	0dB
	COMPRESSOR ON / OFF	ON:CH-3 OFF:CH-4
	COMPRESSOR THRESHOLD	10dB
	COMPRESSOR RATIO	∞ : 1
	COMPRESSOR ATTACK	0.47ms
COMPRESSOR RELEASE	100ms	
DELAY ON/OFF	OFF	
DELAY TIME	0ms	
OUTPUT LINK ON / OFF	OFF	
70V LINE	70V LINE / Lo.imp	70V LINE

LINE OUTPUT 1/2	OUTPUT FADER	0dB
	OUTPUT MUTING	OFF
	EQ BAND	0 BAND
	EQ ON / OFF	OFF
	EQ1 FREQ	31.5Hz
	EQ2 FREQ	106Hz
	EQ3 FREQ	375Hz
	EQ4 FREQ	1.32kHz
	EQ5 FREQ	4.5kHz
	EQ6 FREQ	16kHz
	EQ7-12 FREQ	20kHz
	EQ1-6 Q	1
	EQ7-12 Q	1.5
	EQ1-12 GAIN	0dB
	COMPRESSOR ON / OFF	OFF
	COMPRESSOR THRESHOLD	10dB
	COMPRESSOR RATIO	∞ : 1
	COMPRESSOR ATTACK	0.47ms
	COMPRESSOR RELEASE	100ms
	DELAY ON/OFF	OFF
	DELAY TIME	0ms
	OUTPUT LINK ON / OFF	ON
	LINE OUTPUT 3/4	OUTPUT FADER
OUTPUT MUTING		OFF
EQ BAND		0 BAND
EQ ON / OFF		OFF
EQ1 FREQ		63Hz
EQ2 FREQ		2.5kHz
EQ3 FREQ		20kHz
EQ4-12 FREQ		20kHz
EQ1 Q		1
EQ2 Q		1.5
EQ3 Q		0.47
EQ4-12 Q		1.5
EQ1-12 GAIN		0dB
COMPRESSOR ON / OFF		OFF
COMPRESSOR THRESHOLD		10dB
COMPRESSOR RATIO		∞ : 1
COMPRESSOR ATTACK		0.47ms
COMPRESSOR RELEASE		100ms
DELAY ON/OFF		OFF
DELAY TIME		0ms
OUTPUT LINK ON / OFF		ON

INDEX	SPEAKER OUTPUT 1 INDEX	SP 1
	SPEAKER OUTPUT 2 INDEX	SP 2
	SPEAKER OUTPUT 3 INDEX	SP 3
	SPEAKER OUTPUT 4 INDEX	SP 4
	LINE OUTPUT 1 INDEX	AUX L
	LINE OUTPUT 2 INDEX	AUX R
	LINE OUTPUT 3 INDEX	REC L
	LINE OUTPUT 4 INDEX	REC R

Remotes

Item		Factory setting
AV/RGB INPUT	CH A VIDEO SIGNAL DEFINE	VIDEO
	CH B VIDEO SIGNAL DEFINE	VIDEO
	CH C VIDEO SIGNAL DEFINE	VIDEO
	CH D VIDEO SIGNAL DEFINE	RGB
	CH E VIDEO SIGNAL DEFINE	RGB
REMOTE PARALLEL	INPUT 1 FUNCTION	AV/RGB SELECT A
	INPUT 2 FUNCTION	AV/RGB SELECT B
	INPUT 3 FUNCTION	AV/RGB SELECT C
	INPUT 4 FUNCTION	AV/RGB SELECT D
	INPUT 5 FUNCTION	AV/RGB SELECT E
	INPUT 6 FUNCTION	MASTER VOLUME UP
	INPUT 7 FUNCTION	MASTER VOLUME DOWN
	INPUT 8 FUNCTION	PROJECTOR POWER ON
	INPUT 9 FUNCTION	PROJECTOR POWER STANDBY
	INPUT 10 FUNCTION	EMG CLOSE
	OUTPUT 1 FUNCTION	AV/RGB SELECT A
	OUTPUT 2 FUNCTION	AV/RGB SELECT B
	OUTPUT 3 FUNCTION	AV/RGB SELECT C
	OUTPUT 4 FUNCTION	AV/RGB SELECT D
	OUTPUT 5 FUNCTION	AV/RGB SELECT E
	OUTPUT 6 FUNCTION	MASTER VOLUME MAX (UP)
	OUTPUT 7 FUNCTION	MASTER VOLUME MIN (DOWN)
	OUTPUT 8 FUNCTION	PROJECTOR POWER ON
	OUTPUT 9 FUNCTION	PROJECTOR POWER STANDBY
	OUTPUT 10 FUNCTION	EMG

REMOTE FADER ASSIGN	MASTER INPUT ASSIGN	Not assigned.
	MASTER SPEAKER OUTPUT ASSIGN	Assigned to SPEAKER OUT 1-4.
	MASTER LINE OUTPUT ASSIGN	Assigned to LINE OUT 1/2.
	REMOTE 1-6 INPUT ASSIGN	Not assigned.
	REMOTE 1-6 SPEAKER OUTPUT ASSIGN	Not assigned.
	REMOTE 1-6 LINE OUTPUT ASSIGN	Not assigned.
	MASTER INDEX	MASTER
	REMOTE 1 INDEX	REMOTE 1
	REMOTE 2 INDEX	REMOTE 2
	REMOTE 3 INDEX	REMOTE 3
	REMOTE 4 INDEX	REMOTE 4
	REMOTE 5 INDEX	REMOTE 5
REMOTE 6 INDEX	REMOTE 6	
POWER ON SETTING	LAST MEMORY	
PROJECTOR POWER INFORMATION	SYNC WITH POWER OFF only Undefined.	

NOTICE FOR USERS

© 2004 Sony Corporation. All rights reserved. This manual or the software described herein, in whole or in part, may not be reproduced, translated or reduced to any machine readable form without prior written approval from Sony Corporation.

SONY CORPORATION PROVIDES NO WARRANTY WITH REGARD TO THIS MANUAL, THE SOFTWARE OR OTHER INFORMATION CONTAINED HEREIN AND HEREBY EXPRESSLY DISCLAIMS ANY IMPLIED WARRANTIES OF MERCHANTABILITY OR FITNESS FOR ANY PARTICULAR PURPOSE WITH REGARD TO THIS MANUAL, THE SOFTWARE OR SUCH OTHER INFORMATION. IN NO EVENT SHALL SONY CORPORATION BE LIABLE FOR ANY INCIDENTAL, CONSEQUENTIAL OR SPECIAL DAMAGES, WHETHER BASED ON TORT, CONTRACT, OR OTHERWISE, ARISING OUT OF OR IN CONNECTION WITH THIS MANUAL, THE SOFTWARE OR OTHER INFORMATION CONTAINED HEREIN OR THE USE THEREOF.

Sony Corporation reserves the right to make any modification to this manual or the information contained herein at any time without notice.

The software described herein may also be governed by the terms of a separate user license agreement.

Trademarks

- Celeron is a trademark of Intel Corporation (U.S.A. and other countries).
- Windows is a registered trademark of Microsoft Corporation (U.S.A. and other countries).
- Adobe Acrobat and Adobe Reader are trademarks or registered trademarks of Adobe Systems Incorporated.
- Other system names, productions, and company names appearing in this manual are trademarks or registered trademarks of their respective holders. In this manual, such names are not indicated by ® or TM marks.

